

For commercial use

Model name:

# RBC-AMTU31-E

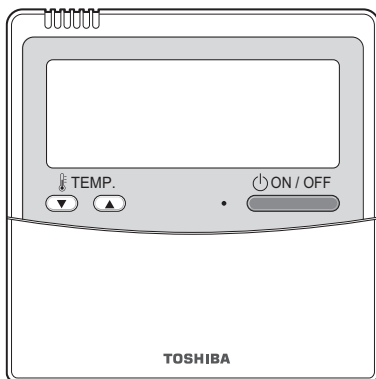

- Read this manual before using the RBC-AMTU31-E remote controller.
- Refer to the Owner's Manual supplied with the indoor unit for any instructions other than operations of the remote controller.

### Multilingual installation manuals and owner's manual



The manuals in the following languages can be downloaded at our website.

Български / Český / Dansk / Deutsch / Ελληνικά / English / Español / Eesti / Suomi / Français / Hrvatski / Magyar / Italiano / 한국어 / Latviešu / Norsk / Nederlands / Polski / Português / Română / Русский / Slovensky / Slovenščina / Svenska / Türkçe / 中文



<https://www.toshiba-carrier.co.jp/global/manual/rbc-amtu31-e.htm>

# Contents

<b>1</b>	<b>Precautions for safety</b> .....	<b>2</b>
<b>2</b>	<b>Part names and functions of the remote controller</b> .....	<b>4</b>
	Display section .....	4
	Operation section .....	6
<b>3</b>	<b>Basic operation</b> .....	<b>8</b>
	Preparation .....	8
	Operations .....	8
	Changing the fan speed .....	8
	Changing the set temperature .....	9
	Power save operation .....	9
<b>4</b>	<b>Timer operation</b> .....	<b>10</b>
	Setting the timer .....	10
	Cancelling the timer .....	10
<b>5</b>	<b>Louver direction</b> .....	<b>11</b>
	4-way cassette type, Compact 4-way cassette type only .....	12
<b>6</b>	<b>Application control</b> .....	<b>17</b>
	Power saving mode .....	17
	Performing settings of the power saving mode .....	17
	8°C operation .....	18
<b>7</b>	<b>Address setting</b> .....	<b>19</b>
	Manual address setup procedure .....	19
	Resetting the address .....	20
	To recognize the position of the corresponding indoor unit though the indoor "UNIT No." is known .....	21
<b>8</b>	<b>DN setting</b> .....	<b>22</b>
	Setting indoor unit DN codes (I.DN) .....	22
	Setting outdoor unit DN codes (O.DN) .....	23
<b>9</b>	<b>Test run</b> .....	<b>24</b>
	Execute a test run .....	24
<b>10</b>	<b>Service monitor function</b> .....	<b>25</b>
<b>11</b>	<b>Troubleshooting</b> .....	<b>26</b>
	Confirmation and check .....	26
	Confirmation of check code .....	26
<b>12</b>	<b>Maintenance</b> .....	<b>27</b>

# 1 Precautions for safety

- Read these "Precautions for safety" carefully before using.
- The precautions described below include important items regarding safety. Observe them without fail. Understand the following details (indications and symbols) before reading the body text, and follow the instructions.
- Keep this Manual at accessible place for future reference.

Indication	Meaning of Indication
 <b>WARNING</b>	Text set off in this manner indicates that failure to adhere to the directions in the warning could result in serious bodily harm (*1) or loss of life if the product is handled improperly.
 <b>CAUTION</b>	Text set off in this manner indicates that failure to adhere to the directions in the caution could result in minor bodily injury (*2) or damage (*3) to property if the product is handled improperly.

- \*1: Serious bodily harm indicates loss of eyesight, injury, burns, electric shock, bone fracture, poisoning, and other injuries which leave aftereffect and require hospitalization or long-term treatment as an outpatient.
- \*2: Bodily injury indicates injury, burns, electric shock, and other injuries which do not require hospitalization or long-term treatment as an outpatient.
- \*3: Damage to property indicates damage extending to buildings, household effects, domestic livestock, and pets.

## **WARNING**

### Installation

- **Do not attempt to install the air conditioner yourself.**  
Ask your dealer or a contractor with specialized experience to install the air conditioner. Electric shocks and/or a fire may result if you attempt to install the air conditioner yourself and the air conditioner ends up not being installed perfectly.
- **Use only with the authorized air conditioner units.**  
Be absolutely sure to use only the authorized air conditioner units designated by the manufacturer. Also, ask a contractor with specialized experience to install them. Electric shocks and/or a fire may result if you attempt to install the parts yourself and the parts end up not being installed perfectly.

### Operation

- **Do not operate the buttons with wet hands.**  
Failure to heed this warning may result in electric shocks and/or trouble.
- **Do not get the control unit wet.**  
Take steps to avoid getting the control unit wet. Failure to heed this warning may result in electric shocks, a fire and/or trouble.
- **If trouble (such as the smell of burning) has occurred, stop operation and turn off the main power switch.**  
Allowing operation to continue while the trouble has not been remedied may cause electric shocks, a fire and/or trouble. Consult your dealer.

### Relocation

- **Do not undertake any repair work yourself.**  
Under no circumstances must you attempt to do any repair work yourself. Instead, consult your dealer or a contractor with specialized experience. Electric shocks and/or a fire may result if you attempt to do repair work yourself and this work ends up not being carried out perfectly.
- **Consult your dealer when the control unit is to be relocated and re-installed.**

 **CAUTION**

---

**Installation**

- **Do not install the remote controller unit where there are high levels of moisture, oils, grease or vibration.**  
Failure to heed this caution may cause trouble.
- **Do not install the remote controller unit direct sunlight or near a heat source.**  
Failure to heed this caution may cause malfunctioning.
- **Do not install the remote controller unit where there are sources of electro-magnetic noise.**  
Failure to heed this caution may cause unintended operation.
- **Do not use this device in locations where children may be present.**

**Operation**

- **Do not drop the product or subject it to strong impact.**  
Failure to heed this caution may cause malfunctioning.
-

# 2 Part names and functions of the remote controller

This remote controller can control up to 16 indoor units.

## ■ Display section

All indicators are displayed in the display example below. Actually, only the selected options will be displayed.

- **SETTING** blinks on the display of the remote controller the first time the power switch is turned on.
- The initial settings progress while **SETTING** is blinking. Start to use the remote controller after **SETTING** has disappeared.

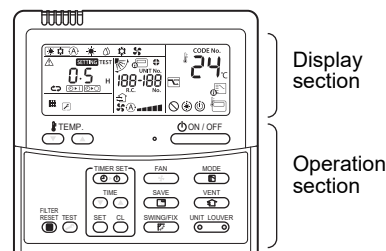

### NOTE

The LCD may temporarily be blurred due to static electricity.

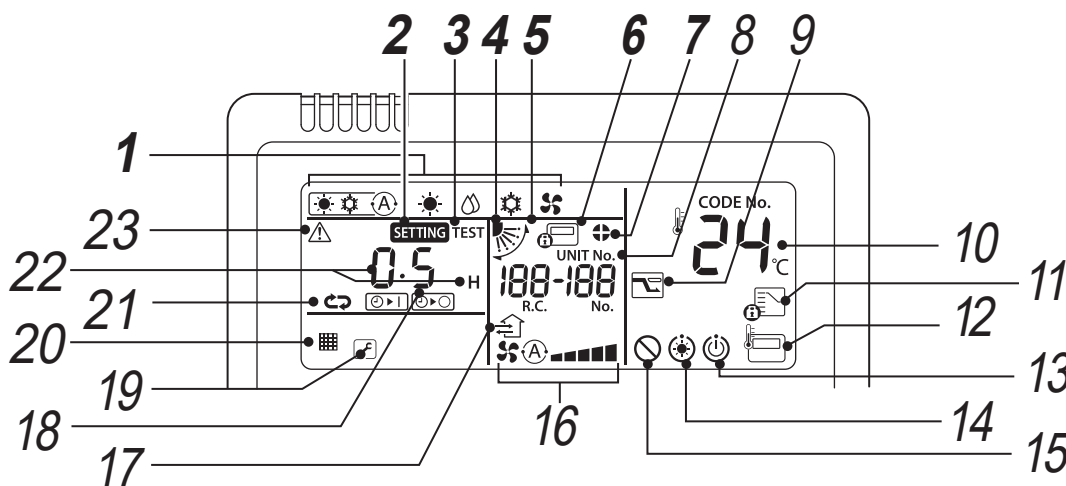

- |  |  |
|--|--|
| <p><b>1 Operation mode indicator</b><br/>Indicates the operation mode selected.</p> <p><b>2 SETTING indicator</b><br/>Displayed when setting the timer or other functions.</p> <p><b>3 TEST run indicator</b><br/>Displayed during test run.</p> <p><b>4 Louver position display</b><br/>Indicates the louver position.</p> <p><b>5 Swing indicator</b><br/>Displayed during up / down movement of the louver.</p> | <p><b>6 Central control indicator</b><br/>Displayed when the air conditioner is controlled centrally and used with central control devices such as the central remote controller. If the use of the remote controller is prohibited by the central control,  blinks when the ON / OFF, MODE, or TEMP. button on the remote controller is pushed, and the buttons do not function. (Settings that can be configured on the remote controller differ depending on the mode of the central control. For details, read the Owner's Manual of the central remote controller.)</p> <p><b>7 Louver lock indicator</b><br/>Displayed when a louver is locked.</p> |
|--|--|

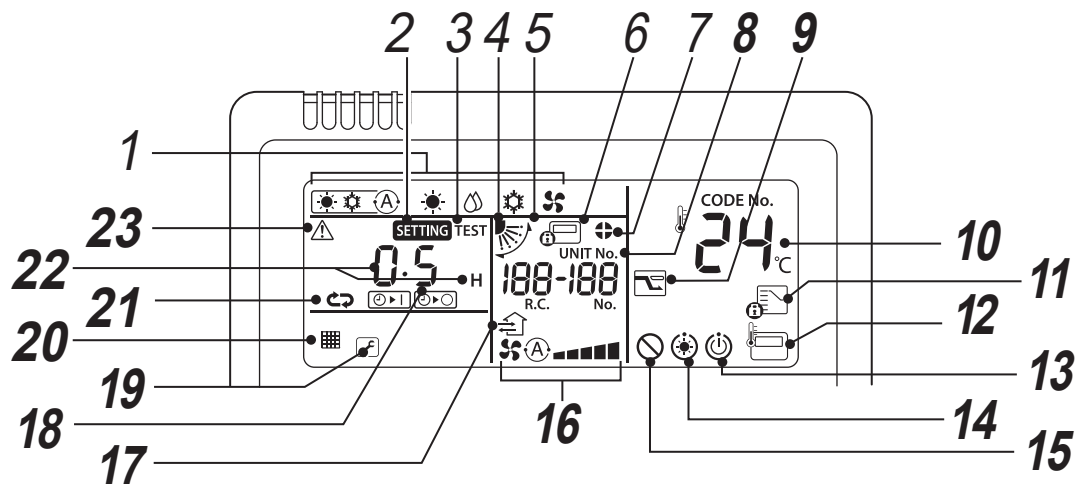

**8 UNIT No. display**

Displays the number of the indoor unit selected. Also displays check code of indoor and outdoor units.

**9 Power saving mode display**

Limits compressor speed (capacity) to save energy.

**10 Set temperature display**

The selected set temperature is displayed.

**11 Operation mode controlled indicator**

Displayed when MODE button is pushed while operation mode is fixed to cool or heat by the air conditioner administrator.

**12 Remote controller sensor indicator**

Displayed when the remote controller sensor is used.

**13 Operation ready display**

This display appears on some types of unit.

**14 Pre-heat indicator**

Displayed when the heating mode is energized or defrost cycle is initiated. While this indication is displayed, the indoor fan stops or operate in fan mode.

**15 No function indicator**

Displayed when the function requested is not available on that type of unit.

**16 Fan speed indicator**

Indicates the selected fan speed.

**17 Ventilation operation display**

This is displayed during the operation of a commercially available ventilation fan when it is connected.

**18 Louver Number display**

(example: [01], [02], [03], [04])

**19 Service display** 

Displayed while the protective device works or a trouble occurs.

**Notice code icon** 

This icon appears on the display when a notice code has occurred.

For details, contact your dealer (distributor).

**20 Filter indicator**

Reminder to clean the filter.

**21 Timer mode indicator**

Displays the timer mode.

**22 Time display**

Indicates time concerning the timer. (Indicates an check code when an abnormality occurs)









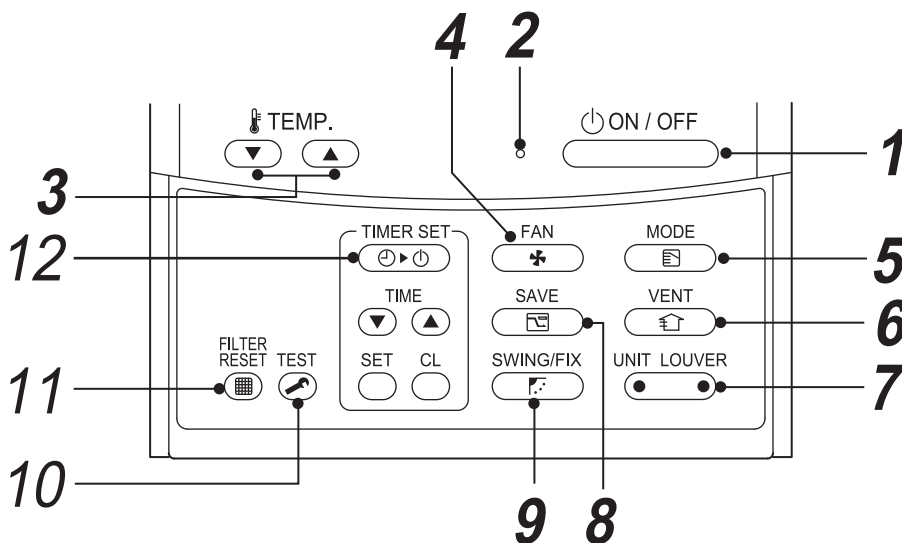

**23 Check indicator**

Displayed when the protective device activates or an abnormality occurs.

## ■ Operation section

Once the settings have been configured, all you need to do is push the  button from then on.



- 1**  **button**  
Turns on the unit when pushed, and turns off when pushed again.
- 2** **Operation lamp**  
Lights up during running.  
Blinks when an abnormality occurs or the protective device activates.
- 3**  **button**  
Adjusts the set temperature.  
Select the desired set point by pushing .
- 4**  **button (Fan speed select button)**  
Selects the desired Fan speed.
- 5**  **button (Operation mode select button)**  
Selects desired operation mode.
- 6**  **button**  
Use when a ventilator (commercially-available) is connected. Push the button to turn on / off the ventilator. Turning on / off the air-conditioner also turns on / off the ventilator.  
\* No ventilator is connected if “” appears on the remote controller display after pushing the  button.
- 7**  **button (Unit / Louver select button)**  
Selects a unit number (left) and louver number (right).  
**UNIT button:**  
If two or more indoor units are controlled by one remote controller, use this button to select a unit to adjust its air blow direction.  
**LOUVER button:**  
Selects a louver to control when adjusting the louver lock setting or wind direction setting separately for each louver.
- 8**  **button (Power save operation)**  
Use to initiate power saving mode.
- 9**  **button**  
Use to select automatic swing or fixed louver position.

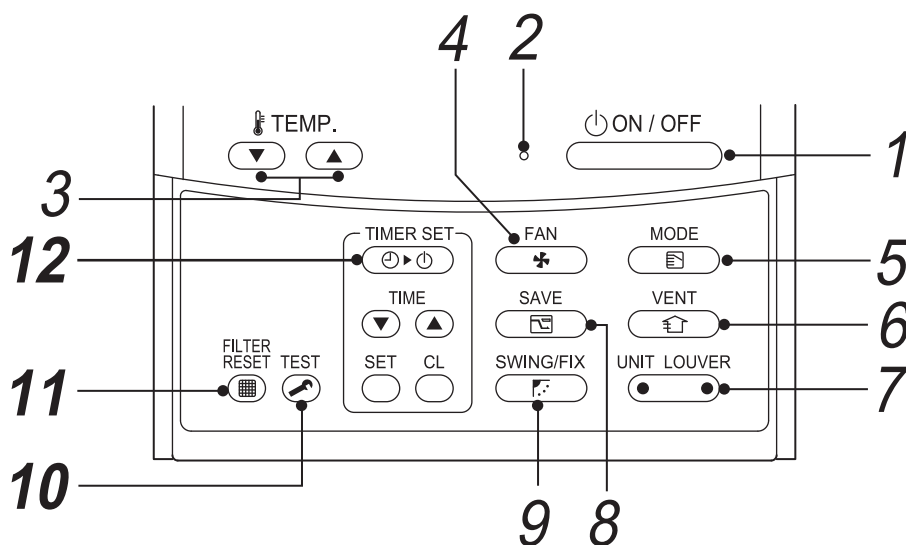

**10**  **button (TEST button)**

Use only for service.  
(During normal operation, do not use this button.)

**11**  **button (Filter reset button)**

Resets "  FILTER" indication after cleaning.

**12**  **button (Timer set button)**

Use to setup the timer.

**OPTION:**

**Remote controller sensor**

Normally the temperature sensor of the indoor unit senses the temperature. The temperature around the remote controller can also be sensed. For details, contact your dealer.

\* Avoid using this function when group control is used as unevenness in room temperature may occur. (Thermostatic control of individual indoor units is not possible.)



# 3 Basic operation

When you use the air conditioner for the first time or change the settings, follow the procedures below. From next time, pushing the  button starts running of the air conditioner with the chosen settings.

## ■ Preparation

### Turn on the power switch



- When turned on, the separation line appears and **SETTING** blinks on the remote controller display.
- \* **The remote controller will not work for about 3 minute after turning on the power. This is not a malfunction.**

### REQUIREMENT

- Keep the power switch turned on during use.
- When you resume using the air conditioner after a long period of disuse, turn on the power switch at least 12 hours before starting running.

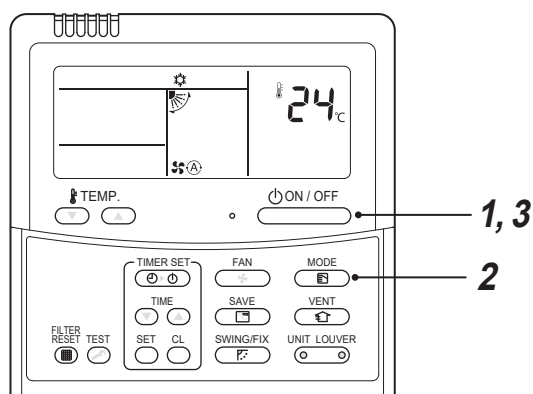
## ■ Operations



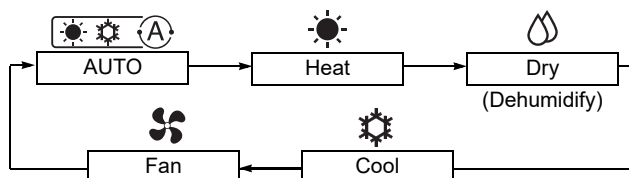

- 1 Push the  button.**  
The operation lamp lights up.
- 2 Push the  button to select a operation mode.**  
Each time you push the button, the operation mode and its icon change in the following order:



Depending on the type of unit connected, the operation modes that cannot be set will not be displayed.

- 3 Push the  button to stop running.**  
The operation lamp turns off.

## ■ Changing the fan speed

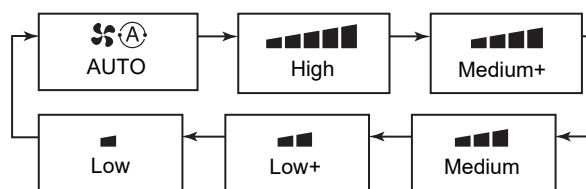

- 1 Push the  button to select a fan speed.**
  - Each time you push the button, fan speed and its indication change in the following order: ("  Auto" cannot be selected in the FAN mode.)
  - \* The available fan speeds vary depending on the indoor unit connected.



- The temperature sensor detects the return air temperature at the indoor unit, which may slightly differ from the actual room temperature depending on installation condition. Set temperature is a target of room temperature.

## ■ Changing the set temperature

### 1 Push the buttons.

Push  to increase the temperature, and  to decrease the temperature. (The set temperature cannot be changed in the fan mode.)

#### NOTE

#### When cooling

Running starts in approximately 1 minute.

#### When Automatic cooling / heating

The operation is automatically switched to heating or cooling based on the difference between the set temperature and the room temperature.

#### When heating

- The air conditioner may continue running in the fan mode for about 30 seconds after stopping heating.
- The heated air comes out after a 3 to 5 minutes of pre-heating with the indoor fan kept turned off. (The pre-heat indicator  is displayed on the remote controller.)

## ■ Power save operation

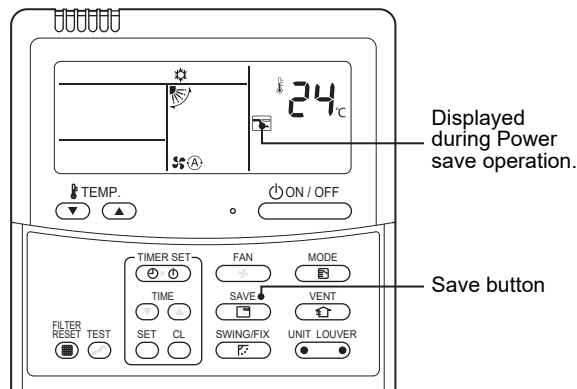

### 1 Push the button during operation.

- Power save operation is activated.
-  is appeared.

### 2 Push button to deactivate Power save operation.

-  is disappeared.

#### NOTE

- Capability of the air conditioner is saved during the Power save operation. The room may not become cool or warm enough.
- Power save operation will not be deactivated by stop operation, change operation mode or turn off the power switch.

# 4 Timer operation

Select a timer type from the following three: (Max. 168 hours)

- OFF timer** : Stops running after the specified period.
- Repeat-OFF timer** : Stops running after the specified period every time you use the air conditioner.
- On timer** : Starts running after the specified period.

## ■ Setting the timer

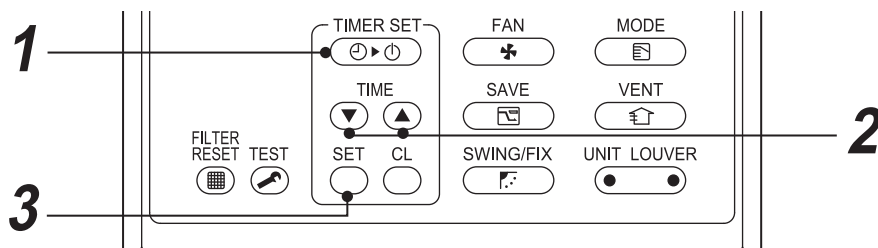

### 1 Push the **TIMER SET** button.

Each time you push the button, the timer mode and indication change in the following order:

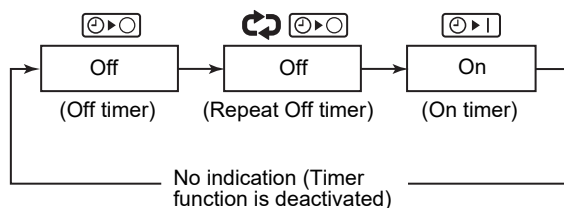

- **SETTING** and the time indicator blink.

### 2 Push the **TIME** buttons to set the period of time until the timer actions.

- The time setting increases in 0.5-hour (30-minute) increments each time you push **▲**. The setting increases in 1-hour increments if it is over 1 d (24 hours). The maximum is 7 d (168 hours).  
On the remote controller, settings between 0.5 h and 23.5 h (\*1) are displayed as is. If it is over 24 hours (\*2), the days and hours appear.
- The time setting decreases in 0.5-hour (30-minute) decrements (0.5 hours to 23.5 hours) or 1-hour decrements (24 hours to 168 hours) each time you push **▼**.

### 3 Push the **SET** button.

- **SETTING** disappears, the time indication is displayed, and **▶|** or **▶|** display flashes.  
(When using the ON timer, all indications other than the time and **▶|** turn off.)

## ■ Cancelling the timer

### 1 Push the **CL** button.

The timer indicator disappears.

#### NOTE

- When using Repeat OFF timer, pushing the **ON/OFF** button after stopping by the timer starts running again and the timer will stop the running again after the specified period.
- When using OFF timer, the timer indication temporarily disappears for about 5 seconds by pushing the **SWING/FIX** button. This occurs due to the processing in the remote controller, and is not a malfunction.

### Example of remote controller display

- **23.5 hours (\*1)**



- **34 hours (\*2)**

**1d** indicates 1 day (24 hours).  
**10h** indicates 10 hours. (Total: 34 hours)

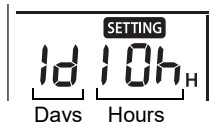

# 5 Louver direction

Only types of unit having a wind direction adjustment function can be controlled.

For precautions for use of the air conditioner, refer to the air conditioner owner's manual.

## ◆ To set the louver direction

**1** Push the  button during running.  
The louver direction changes with each push of the button.

### ▼ For heating

Point the louver downward.  
If not pointing downward, hot air may not reach the floor.

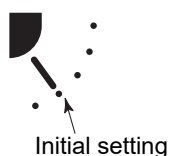

### ▼ For cooling

Point the louver horizontally.  
If pointing downward, dew may form on the surface of the air discharge port and may drop down.

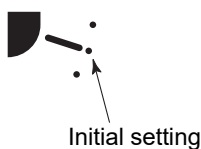

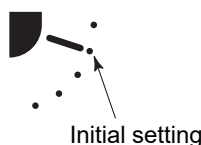

### ▼ For fan

Select a wind direction.



## ◆ To start swinging

**1** Push the  button repeatedly to set the louver direction to the lowest position, then push  again.

The SWING  indicator is displayed and the louver begins swinging.

### ▼ In all operations

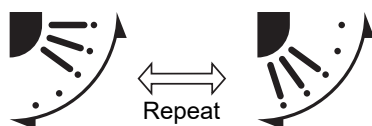

## ◆ To stop swinging

**1** Push the  button at the desired position while the louver is swinging.

- Push the  button repeatedly to change the louver position again.

- \* However, even if the  button is pushed while the louver is swinging, one of the indications below may sometimes be displayed and may not set the louver to the highest position.

### ▼ Indications when swinging is stopped





In this case, push the  button again after 2 seconds.

- \* In COOL / DRY operation, the louver does not stop as it directs downward. If stopping the louver as it directs downward during swing operation, it stops after moving to the third position from the highest position.

### ▼ Indications when swinging is stopped



### ◆ Unit select

- When two or more indoor units are controlled with one remote controller, the louver direction can be set for each indoor unit by selecting them individually.
- To set louver direction individually, push the  button (left side of the button) to display an indoor unit number in the control group. Then set the louver direction of the displayed indoor unit.
- When no indoor unit number is displayed, all indoor units in the control group can be controlled simultaneously.
- Each time you push the  (left side of the button), the indication changes as follows:



### ■ 4-way cassette type, Compact 4-way cassette type only

#### ◆ To set the louvers individually

##### 1 Push the button (left side of the button) during running to select a unit.

The unit number changes each time you push the button.



\* When no unit number is displayed, all units are selected.

##### 2 Push the button (right side of the button) to select a louver.

Each time you push the button, the indicator on the left of the remote controller changes as follows:



\* When no louver number is displayed, all 4 louvers are selected.

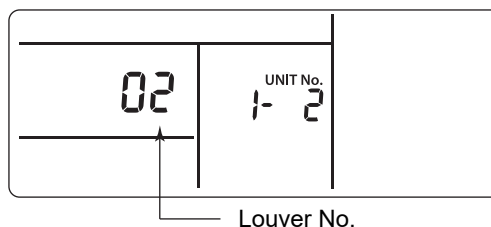

### 4-way cassette type

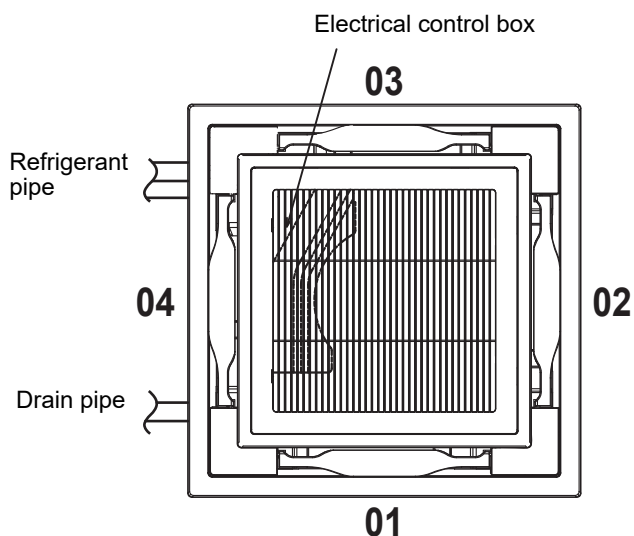

### Compact 4-way cassette type

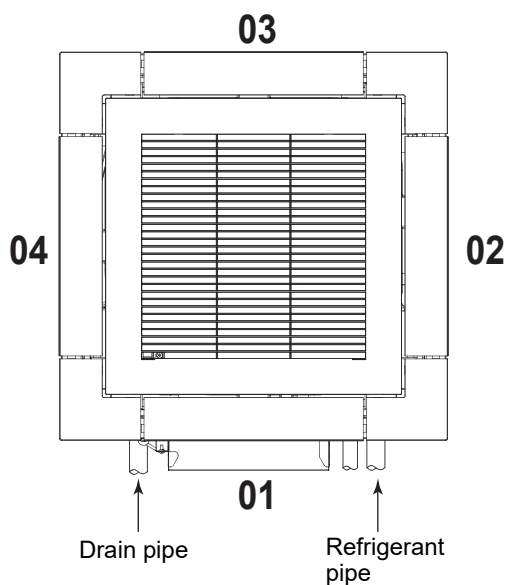

### ◆ Setting the swing pattern

- 1 Push and hold the **SWING/FIX** button for at least 4 seconds while the operation is stopped. **SETTING** blinks.
- 2 Push the **UNIT LOUVER** button (left side of the button) to select a unit. The unit number changes each time you push the button.

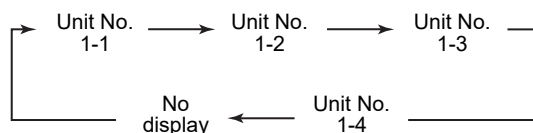

The fan of the selected unit runs, and the louver swings.

- 3 Push the **TIME** buttons to select a swing type.

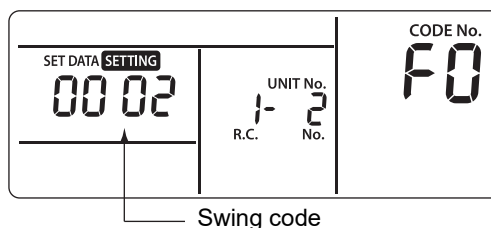

Swing code	Movement pattern
0001	Standard swing (factory default)
0002	Dual swing
0003	Cyclic swing

#### REQUIREMENT

Do not set [0000].  
(The louver may be damaged.)

- 3 Push the **SWING/FIX** button to confirm the direction of the selected louver. Each time you push the button, the indication changes as follows:

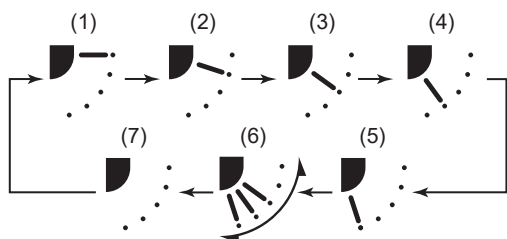

\* When cooling or drying, (4) and (5) are not displayed.

**4** Push the  button.

**5** Push the  button to finish the setting.

**▼ Standard swing**

All four louvers swing simultaneously at the same angle.

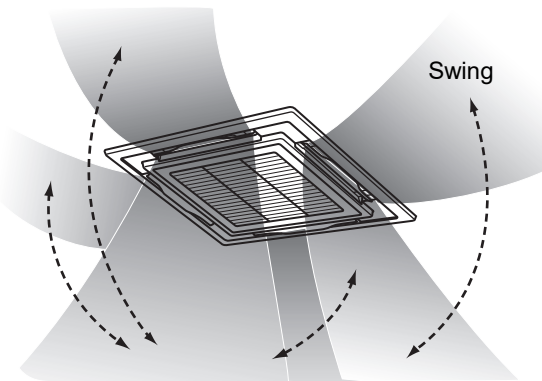

**▼ Dual swing**

- Adjoining louvers alternately point horizontally and downward to heat the room evenly.
- Air blown downward reaches the floor, and air blown horizontally is spread to circulate heat.

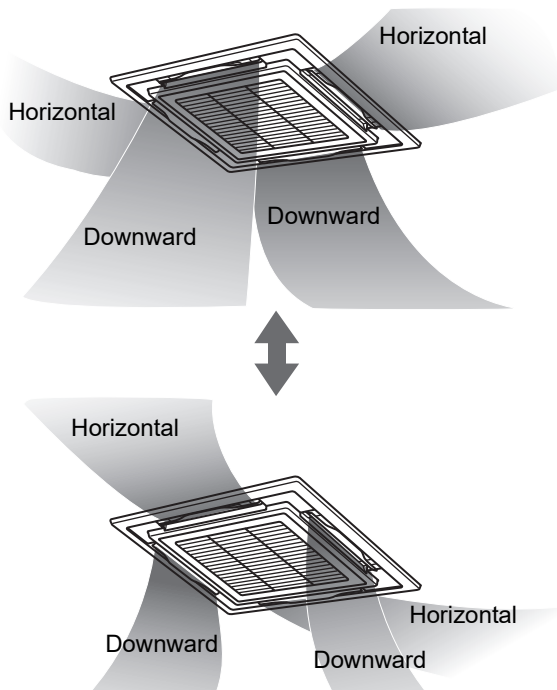

**▼ Cyclic swing**

All four louvers swing at different times like waves.

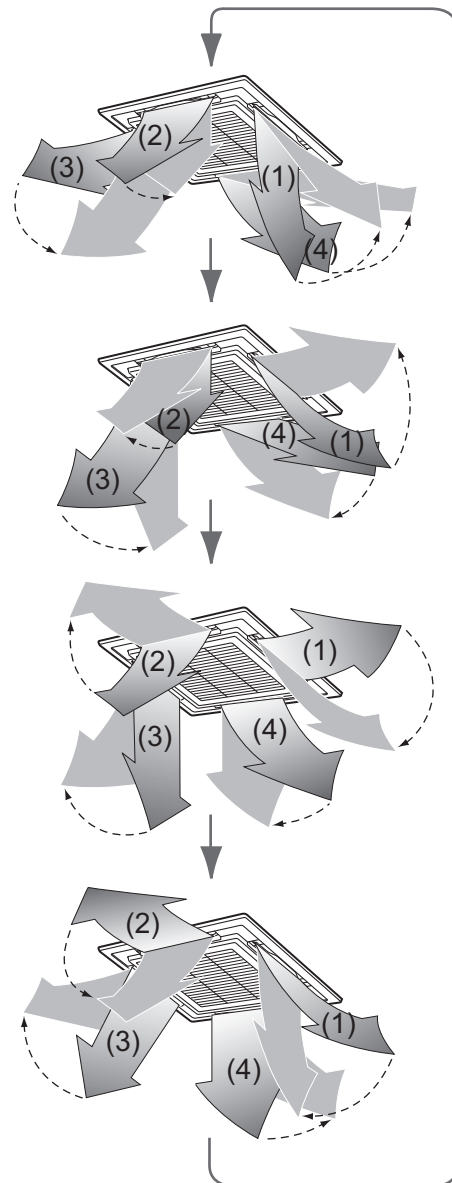

### ◆ Setting the louver lock

**1** Push and hold the  button (right side of the button) for at least 4 seconds while running is stopped.

**SETTING** blinks.

- When no unit number is displayed, all units are selected.

**2** Push the  button (left side of the button) to select a unit.

The unit number changes each time you push the button.

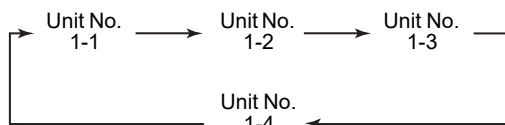

The fan of the selected unit runs, and the louver swings.

**3** Push the   buttons to display the number of the louver to fix its direction.



The selected louver swings.

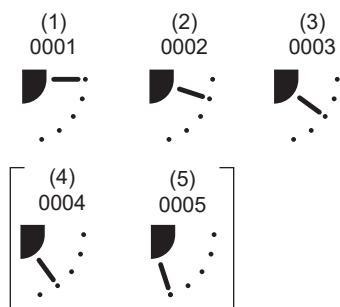

**4** Push the   buttons to select the direction of the louver you do not want to swing.



\* If (4) or (5) is selected, condensation may occur during cooling.

**5** Push the  button to confirm the setting. When the setting is confirmed, the  mark lights up.

(To set the louver lock of another unit, repeat from Step 2. To set another louver lock of the same unit, repeat from Step 3.)

**6** Push the  button to finish the setting.

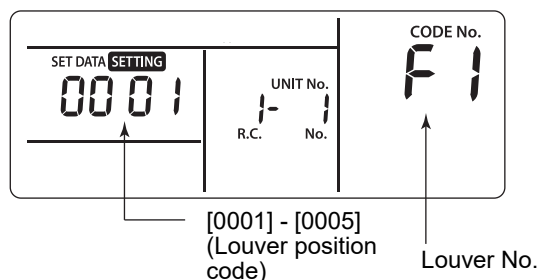

\* [F1] appears in the "CODE No." section on the remote controller. This indicates that the louver [01] shown in the following figure is selected.

### 4-way cassette type

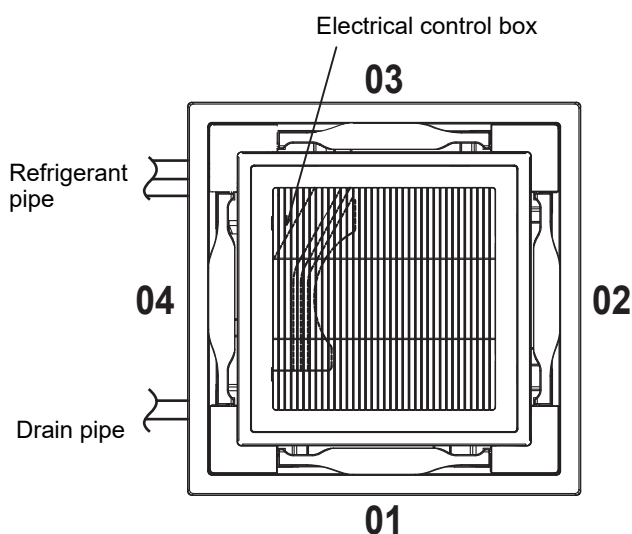

### Compact 4-way cassette type

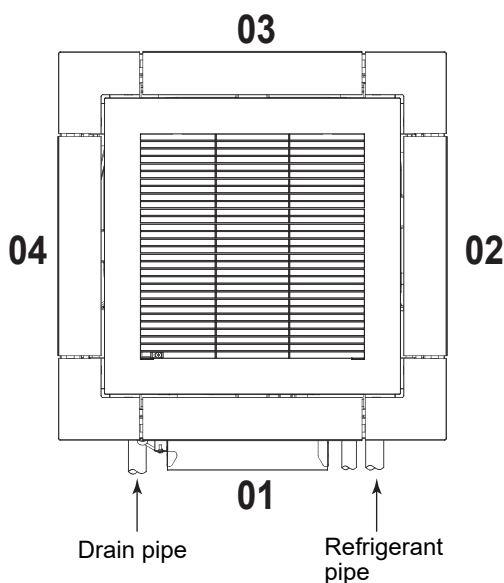



**NOTE**

Even in louver lock mode, the louver temporarily moves in the following cases:

- When the air conditioner is stopped
- When heating starts
- When defrosting
- When thermo. off.

**◆ Releasing the louver lock**

Set [0000] in Step 4 of "Setting the louver lock".

The  mark disappears.

- \* Steps 1 - 3 and 5, 6 of "Setting the louver lock" also apply to releasing the lock.



# 6 Application control

## ■ Power saving mode

The power saving mode saves energy by limiting the maximum current which will effect heating or cooling capacity that the unit can generate.

Push  button during operation.

- The air conditioner enters power saving mode.
-  appears on the display.

Power saving mode will stay in effect until it is cancelled.

To cancel the power saving mode, push  button again.

-  disappears.

## ■ Performing settings of the power saving mode

- \* When group control is performed in a complex system, it is necessary to configure the settings for each outdoor unit.
- \* This function is not available depending on the type of unit connected.

**1** Push  button for 4 seconds or more when the air conditioner is not working.

**SETTING** flashes.  
Indicates "CODE No." [C2].

**2** Select an indoor unit to be set by pushing  (left side of the button).

Each time the button is pushed, unit numbers change as follows:



The fan of the selected unit runs.

**3** Adjust the power save setting by pushing  buttons.

Each push of the button changes the power level by 1% within the range from 100% to 50%.

\*The factory default is 75%.

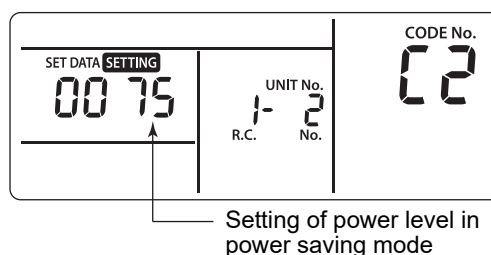

**4** Determine the setting by pushing  button.



**5** Push  button to complete the setting.

## ■ 8°C operation

Pre-heating operation can be set for cold regions where room temperature drops to below zero.

### 1 Push + + buttons simultaneously for 4 seconds or more when the air conditioner is not working.

After a while, the display part flashes as shown below. Check the Displayed "CODE No." is [10].

- When the "CODE No." is other than [10], push  button to erase the display and repeat procedure from the first step.  
(After pushing  button, operation of the remote controller is not accepted for approx. 1 minute.)

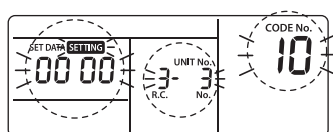

The content of "SET DATA" displayed with "CODE No." [10] changes depending on the type of indoor unit.

### 2 Every time button is pushed, the indoor "UNIT No." in the group control is displayed in order. Select the indoor unit of which setup is changed. In this time, the position of the indoor unit of which setup is changed can be confirmed because fan of the selected indoor unit operate.

### 3 Specify "CODE No." [d1] buttons.

### 4 Select "SET DATA" [0001] buttons.

SET DATA	8°C Operation setting
0000	None (Factory default)
0001	8°C Operation setting

### 5 Push button. In this time, the setup finishes when the display changes from flashing to lighting.

### 6 Push button. (Setup is determined.) When button is pushed, the display disappears and the status becomes the usual stop status. (When button is pushed the operation from the remote controller is not accepted for approx. 1 minute.)

# 7 Address setting

## [Procedure example]

### Manual address setup procedure

While the operation stops, change the setup.  
(Stop the operation of the unit.)

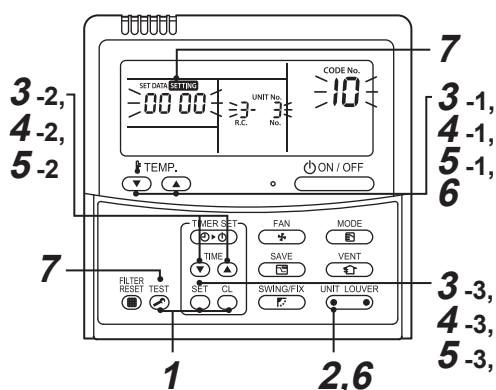

**1** Push **SET** + **CL** + **TEST** buttons simultaneously for 4 seconds or more. After a while, the display part flashes as shown below. Check the displayed "CODE No." is [10].

- When the "CODE No." is other than [10], push **TEST** button to erase the display and repeat procedure from the first step.  
(After pushing **TEST** button, operation of the remote controller is not accepted for approx. 1 minute.)  
(For a group control, No. of the firstly displayed indoor unit becomes the header unit.)

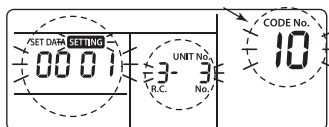

The content of "SET DATA" displayed with "CODE No." [10] changes depending on the type of indoor unit.

**2** Every time **UNIT LOUVER** button is pushed, the indoor "UNIT No." in the group control is displayed in order. Select the indoor unit of which setup is changed.

In this time, the position of the indoor unit of which setup is changed can be confirmed because fan of the selected indoor unit operate.

**3**

- Specify "CODE No." [12] with **TEMP.** buttons. ("CODE No." [12]: Line address)
- Change the line address from [3] to [2] with **TIME** buttons.
- Push **SET** button.  
In this time, the setup finishes when the display changes from flashing to lighting.

Indoor "UNIT No." before setup change is displayed.

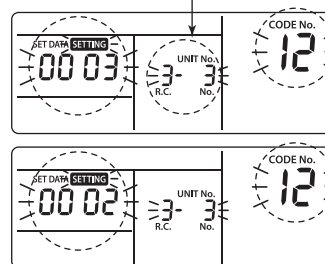

**4**

- Specify "CODE No." [13] with **TEMP.** buttons. ("CODE No." [13]: Indoor address)
- Change the indoor address from [3] to [2] with **TIME** buttons.
- Push **SET** button.  
In this time, the setup finishes when the display changes from flashing to lighting.

Indoor "UNIT No." before setup change is displayed.

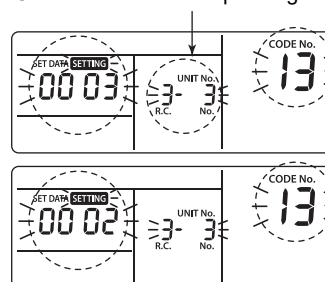

### 5

1. Specify "CODE No." [14] buttons.  
("CODE No." [14]: Group address)
2. Change the "SET DATA" from [0001] to [0002] buttons.  
("SET DATA" [Header unit: 0001] [Follower unit: 0002])
3. Push button.

In this time, the setup finishes when the display changes from flashing to lighting.

Indoor "UNIT No." before setup change is displayed.

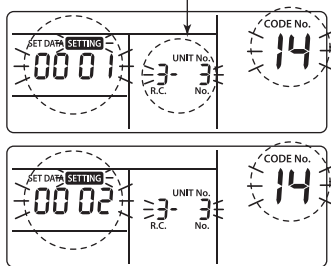

### 6

If there is other indoor unit to be changed, repeat procedure 2 to 5 to change the setup.

When the above setup has finished, push to select the indoor "UNIT No." before change of setup, specify "CODE No." [12], [13], [14] in order with buttons, and then check the changed contents.

Address change check Before change: [3-3-1] → After change: [2-2-2]

Pushing button clears the contents of which setup was changed.  
(In this case, procedure from 2 is repeated.)

Indoor "UNIT No." before setup change is displayed.

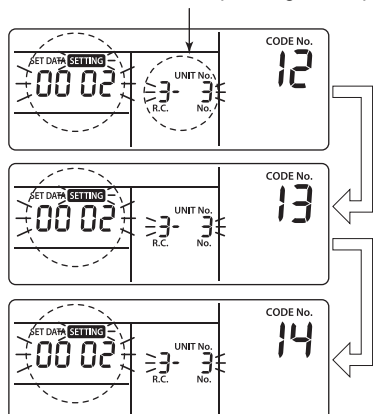

### 7

After check of the changed contents, push button. (Setup is determined.) When button is pushed, the display disappears and the status becomes the usual stop status. (When button is pushed the operation from the remote controller is not accepted for approx. 1 minute.)

- If the operation from the remote controller is not accepted even 1 minute or more passed after pushing button, it is considered that the address setup is incorrect.

In this case, the automatic address must be again set up.

Therefore repeat procedure of the setup change from the Procedure 1.

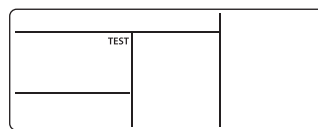

## Resetting the address

(Resetting to the factory default (address undecided))

Clearing each address separately using a wired remote controller.

Set the system address, indoor unit address and group address to [00Un] using a wired remote controller.

(For the setting procedure, refer to the address setting procedures using the wired remote controller on the previous pages.)

## ■ To recognize the position of the corresponding indoor unit though the indoor "UNIT No." is known

Check the position during operation stop.  
(Stop operation of the set.)

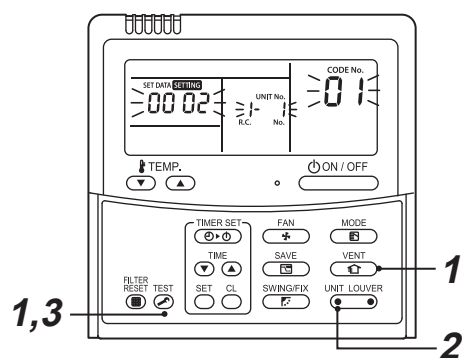

### 3 After confirmation, push **TEST** button to return the mode to the usual mode.

When **TEST** button is pushed, the display disappears and the status becomes the usual stop status.  
(When **TEST** button is pushed the operation from the remote controller is not accepted for approx. 1 minute.)

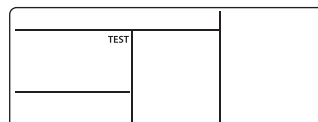

### 1 Push **TEST** + **VENT** buttons simultaneously for 4 seconds or more.

After a while, the display part flashes and the display appears as shown below.  
In this time, the position can be checked because fan of the indoor unit operate.

- For the group control, the indoor "UNIT No." is displayed as [ALL] and fans of all the indoor units in the group control operate.  
Check the displayed "CODE No." is [01].
- When the "CODE No." is other than [01], push **TEST** button to erase the display and repeat procedure from the first step.  
(After pushing **TEST** button, operation of the remote controller is not accepted for approx. 1 minute.)

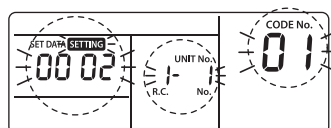

The content of "SET DATA" displayed with "CODE No." [10] changes depending on the type of indoor unit.

### 2 In the group control, every time **UNIT LOUVER** button is pushed, the indoor "UNIT No." in the group control is displayed in order.

In this time, the position of the indoor unit can be confirmed because only fan of the selected indoor unit operate.

(For a group control, No. of the firstly displayed indoor unit becomes the header unit.)

# 8 DN setting

## ■ Setting indoor unit DN codes (I.DN)

### How to set an indoor unit DN code from the wired remote controller

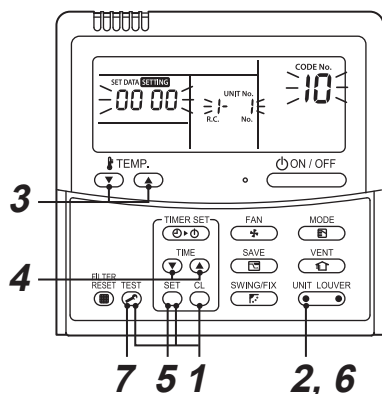

- 4 Use  $\downarrow$   $\uparrow$  buttons to change the setting being displayed to the desired setting.
- 5 Push  $\text{SET}$  button.
- 6 After making the above change, push  $\text{UNIT LOUVER}$  (left side of the button) to check the new setting.
- 7 Push the  $\text{TEST}$  button to finish the setting.

- 1 Push  $\text{SET}$  +  $\text{CL}$  +  $\text{TEST}$  buttons simultaneously for 4 seconds or more.

(In the case of group control, the "UNIT No." displayed first is the number of the header unit.)

- 2 In the case of group control, push  $\text{UNIT LOUVER}$  (left side of the button) to select the No. of the indoor unit whose address you want to change.

The fan and louver of the selected indoor unit start to operate.

- 3 Specify "CODE No." with  $\downarrow$   $\uparrow$  buttons.

- If you select a 3-digit code, the display will be as follows, and the 3rd digit will be displayed where the "UNIT No." was displayed.

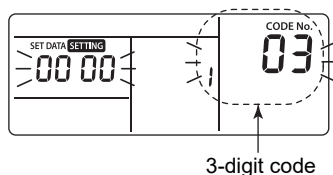

- If you want to check the "UNIT No.", push  $\text{UNIT LOUVER}$  (left side of the button). The "UNIT No." display flashes three times. After the third flashing, the display returns to the third-digit display.

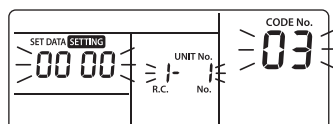

## ■ Setting outdoor unit DN codes (O.DN)

Only types of unit having the relevant function can be controlled.

### How to set an outdoor unit DN code from the wired remote controller

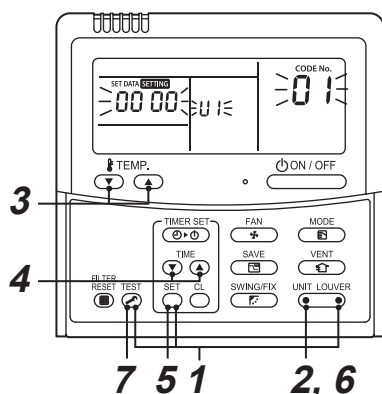

- 1** Push **TEST** + **SET** + **UNIT LOUVER** (right side of the button) buttons simultaneously for 4 seconds or more.  
(In the case of group control, the "UNIT No." displayed first is the number of the header unit.)
- 2** To shift from the header unit [U1] to another unit, push **UNIT LOUVER** (left side of the button) to select the No. of the desired outdoor unit.  
The fan of the selected outdoor unit starts to operate.
- 3** Specify "CODE No." with **TEMP.** buttons.
- 4** Use **TIME** buttons to change the setting being displayed to the desired setting.
- 5** Push **SET** button.
- 6** After making the above change, push **UNIT LOUVER** (left side of the button) to check the new setting.
- 7** Push the **TEST** button to finish the setting.

\* Type of outdoor unit that does not have a function, although the display itself changes after the procedure in step 1. However, neither the code nor the setting will not be displayed, and the display will be back to the previous one.



# 9 Test run

## Execute a test run

Operate the unit with the wired remote controller as usual.

For the procedure of the operation, refer to the attached Owner's Manual.

A forced test run can be executed in the following procedure even if the operation stops by thermostat-OFF.

In order to prevent a serial operation, the forced test run is released after 60 minutes have passed and returns to the usual operation.

### CAUTION

Do not use the forced test run for cases other than the test run because it applies an excessive load to the devices.

## Wired remote controller

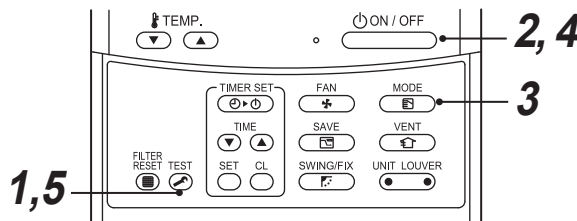

- 1 Push button for 4 seconds or more. "TEST" is displayed on the display part and the selection of mode in the test mode is permitted.

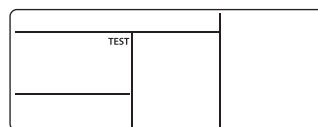

- 2 Push button.
- 3 Select the operation mode with button, "Cool" or "Heat".
  - Do not run the air conditioner in a mode other than "Cool" or "Heat".
  - The temperature controlling function does not work during test run.
  - The detection of trouble is performed as usual.

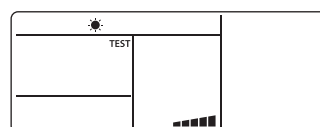

- 4 After the test run, push button to stop a test run. (Display part is same as procedure 1.)
- 5 Push button to cancel (release from) the test run mode. ("TEST" disappears on the display and the status returns to a normal.)

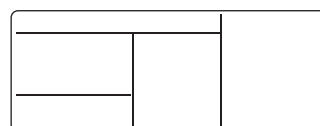

# 10 Service monitor function

This function is available to call the service monitor mode from the remote controller during a test run to acquire temperatures of sensors of the remote controller, indoor unit, and outdoor unit.

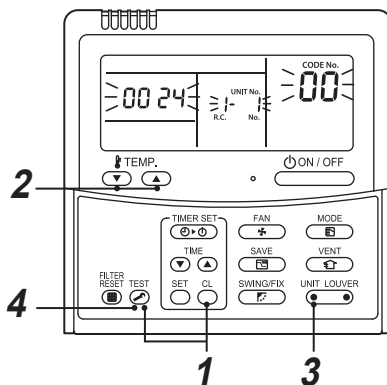

- 1** Push **CL** and **TEST** buttons simultaneously for at least 4 seconds to call the service monitor mode. The service monitor indicator lights up and the header indoor unit number is displayed first. "CODE No." [00] is also displayed.
- 2** Pushing **TEMP.** buttons, select the number of sensor "CODE No." to be monitored. (See the following table.)
- 3** Pushing **UNIT LOUVER** (left side of the button), select an indoor unit to be monitored. The sensor temperatures of indoor units and their outdoor unit in the control group are displayed.
- 4** Push **TEST** button to return to the normal display.

For the content of the DN code that is displayed, refer to the air conditioner installation manual.

# 11 Troubleshooting

## Confirmation and check

When a problem occurred in the air conditioner, the check code and indoor "UNIT No." appear on the display part of the remote controller. The check code is only displayed during the operation. If the display disappears, operate the air conditioner according to the following "Confirmation of check code" for confirmation.

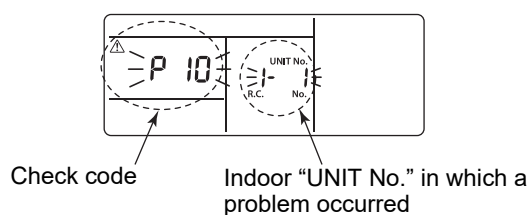

## Confirmation of check code

When a problem occurred on the air conditioner, the check code can be confirmed with the following procedure. (The check code is stored in memory up to 4 check codes.)

The check code can be confirmed from both operating status and stop status.

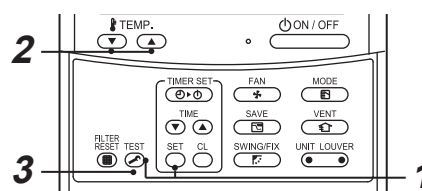

- 1 When **SET** and **TEST** buttons are pushed simultaneously for 4 seconds or more, the following display appears.

If "✓" is displayed, the mode enters in the check code mode.

- [01: Order of check code] is displayed in "CODE No."
- "Check code" is displayed in CHECK.
- [Indoor unit address in which a problem occurred] is displayed in "UNIT No."

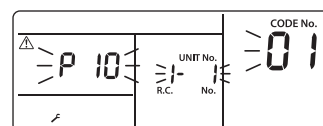

- 2 Every pushing of **TEMP.** button used to set temperature, the check code stored in memory is displayed in order.

The numbers in "CODE No." indicate "CODE No." [01] (latest) → [04] (oldest).

### REQUIREMENT

Do not push **CL** button because all the check code of the indoor unit will be deleted.

- 3 After confirmation, push **TEST** button to return to the usual display.

# 12 Maintenance

To clean the remote controller, wipe it with a dry soft cloth. Do not wash with water, which may cause a malfunction.

## WARNING

For daily maintenance including Air Filter cleaning, make sure to ask the qualified service person particularly for the following types of indoor unit as the maintenance requires high-place work;

- 4-way cassette type
- Compact 4-way cassette type
- 2-way cassette type
- 1-way cassette type
- Ceiling type
- Concealed duct standard type
- Concealed duct high static type
- Slim duct type

## CAUTION

Do not push buttons with wet hands.

Doing so may result in electric shock.

### Cleaning the filters

- When the filter indicator is displayed on the remote controller, clean the filters.
- Ask qualified service person to clean the filters for the types of indoor unit listed in the warning on the top of this chapter.
- Clogged filters may lower the cooling and heating performance.

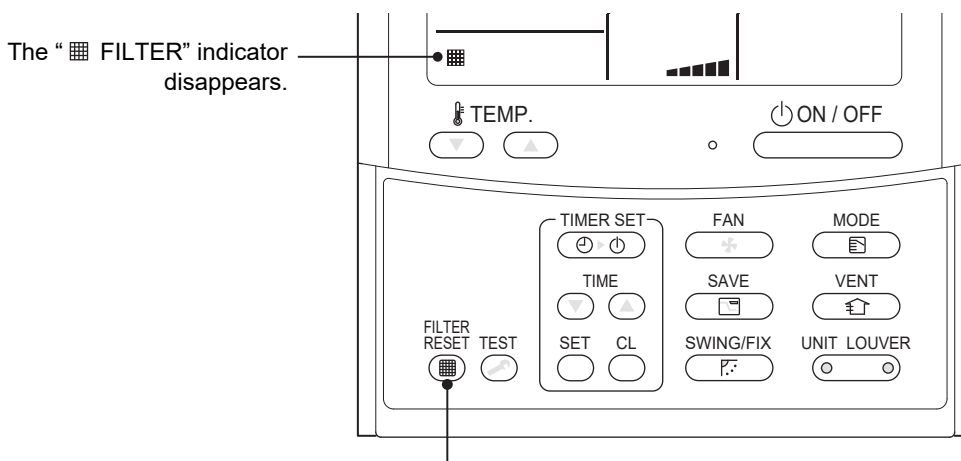

## Manufacturer / Importer

Name of manufacturer ( 制造商 )

**Toshiba Carrier Corporation**

**东芝开利株式会社**

Address, city, country ( 住址 )

72-34 Horikawa-cho, Saiwai-ku, Kawasaki-shi, Kanagawa-ken

212-0013, JAPAN

神奈川県川崎市幸区堀川町 72 番地 34

Name of the Importer/Distributor in EU

Toshiba Carrier EUROPE S.A.S

Address, city, country

Route de Thil 01120 Montluel FRANCE

Name of the Importer/Distributor in UK

Toshiba Carrier UK Ltd

Address, city, country

Porsham Close, Belliver Industrial Estate,

PLYMOUTH, Devon, PL6 7DB. United Kingdom

在中国的进口商 / 分销商名称

东芝开利空调销售 ( 上海 ) 有限公司

地址, 城市, 国家

上海市西藏中路 268 号来福士广场办公楼 501 室





# **Toshiba Carrier Corporation**

336 TADEHARA, FUJI-SHI, SHIZUOKA-KEN 416-8521 JAPAN

**DEB9509002**